

LINEAGROUND HP DALI RGBW

COD 201102 201106 201110 201114

ASSEMBLY AND OPERATING INSTRUCTIONS:



COD 201102
protection class III
products that can only be operated with protected extra-low voltage

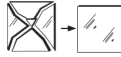

- replace the damaged protective glass
- sostituire i vetri di protezione se danneggiati
- die Beschädigten Schutzgläser ersetzen
- remplacer les verres de protection abimés
- glass features: plane float glass - safety tempered
- caratteristiche vetro: vetro piano float di sicurezza temperato
- Glaseigenschaften: Float-Flachglas, gehärtetes Sicherheitsglas
- caractéristiques du verre: type de verre: plan "float" de sûreté trempé



COD. 201106 – 201110 - 201114

-Class I fitting electric grounding is needed



-getting rid of as urban waste forbidden
-separate collection is mandatory when the product is at the end of its life

CE Made in Italy **IP67 IK10**



Retain the instructions

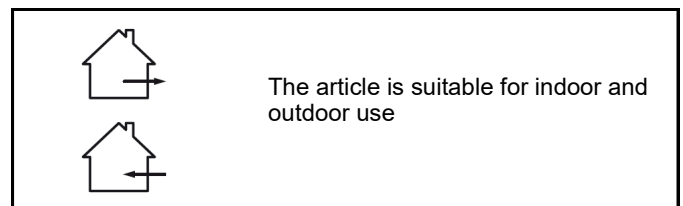

The article is suitable for indoor and outdoor use

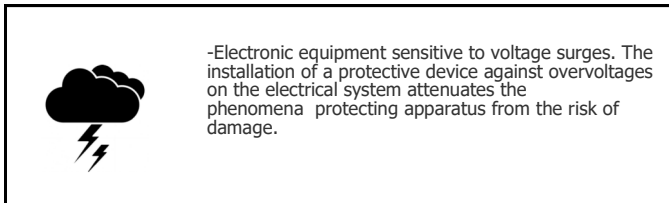

-Electronic equipment sensitive to voltage surges. The installation of a protective device against overvoltages on the electrical system attenuates the phenomena protecting apparatus from the risk of damage.

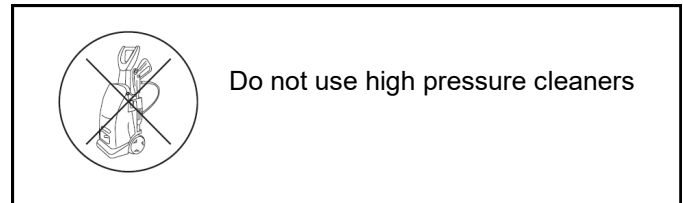

Do not use high pressure cleaners

NB: These assembly instructions must be given to end users for correct maintenance and so that they know how to change the bulb. The appliance must not be tampered with or transformed and it must be installed and used as supplied and in compliance with the National Rules on Installations. Any non-compliant installations will invalidate all forms of guarantee. The company cannot be held responsible for damage caused by incorrect assembly.

<p>COD. 201102</p>	<p>LUMINAIRE</p>	<p>310 mm</p> <p>76 mm</p> <p>102 mm</p> <p>150 mm</p>	<p>LINEAGROUND 300 HP DALI RGBW</p>
<p>310 mm</p>	<p>RECESS HOUSING</p>	<p>294 mm</p> <p>62 mm</p> <p>145 mm</p> <p>109 mm</p>	<ul style="list-style-type: none"> -Power consumption : 10W -Voltage : 24 Vdc -Color Temperature : RGBW -Beam angle : 15° 30° 60° - 10°x60° elliptical -Insulation class: III -IP protection: IP67 -IK rating IK10 -Adjustable: +15°-15° -Gross weight: 3kg -Photobiological risk RG1 – IEC/TR 62778:2014 -Glass temperature 51°C -Max static weight 5000kg
<p>COD. 201106</p>	<p>LUMINAIRE</p>	<p>600 mm</p> <p>76 mm</p> <p>102 mm</p> <p>150 mm</p>	<p>LINEAGROUND 600 HP DALI RGBW</p>
<p>600 mm</p>	<p>RECESS HOUSING</p>	<p>584 mm</p> <p>62 mm</p> <p>145 mm</p> <p>109 mm</p>	<ul style="list-style-type: none"> -Power consumption : 20W -Voltage : 220-240V 50-60Hz -Color Temperature : RGBW -Beam angle : 15° 30° 60° - 10°x60° elliptical -Insulation class: I -IP protection: IP67 -IK rating IK10 -Adjustable: +15°-15° -Gross weight: 5,5kg -Photobiological risk RG1 – IEC/TR 62778:2014 -Glass temperature 51°C -Max static weight 5000kg

COD. 201110



LUMINAIRE

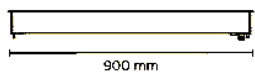

RECESS HOUSING

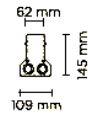
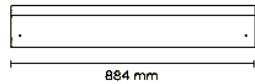

LINEAGROUND 900 HP DALI RGBW

- Power consumption : 30W
- Voltage : 220-240V 50-60Hz
- Color Temperature : RGBW
- Beam angle : 15° 30° 60° - 10°x60° elliptical
- Insulation class: I
- IP protection: IP67
- IK rating IK10
- Adjustable: +15°-15°
- Gross weight: 7kg
- Photobiological risk RG1 – IEC/ TR 62778:2014
- Glass temperature 51°C
- Max static weight 5000kg

COD. 201114

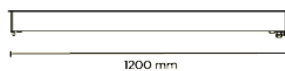

RECESS HOUSING

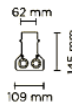
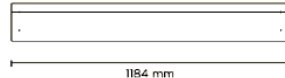

LINEAGROUND 1200 HP DALI RGBW

- Power consumption : 40W
- Voltage : 220-240V 50-60Hz
- Color Temperature : RGBW
- Beam angle 15° 30° 60°- 10°x60° elliptical
- Insulation class: I
- IP protection: IP67
- IK rating IK10
- Adjustable: +15°-15°
- Gross weight: 9,5kg
- Photobiological risk RG1 – IEC/ TR 62778:2014
- Glass temperature 51°C
- Max static weight 5000kg

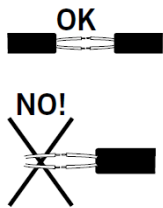

Use only supply cables with double case



Use only <HAR> flexible cables of suitable diameter. DO NOT USE HARD CABLES OR ARMORED CABLE (hard cable could effect the IP65-IP67 protection)

LINEAGROUND HP DALI RGBW

- The luminaire is supplied by us with LED illuminator already installed with built in SELV power supply.
- If the external flexible cable of this luminaire is damaged, it must only be replaced by the manufacturer, its assistance service, or equivalent qualified personnel, in order to avoid dangers.
- Luminaire for installation in restricted access areas
- The cable and the fixture must not be tampered with for any reason.
- It is essential to do a frequent cleaning of the glass and of the outer surface of the fixture to avoid build up of mud and dirtiness resulting in dangerous overheating due to uncorrect light and heat dissipation. Clean carefully the glass screen removing limestone deposits by means of a scraper.
- The replacement must be done by a qualified electrician.
- To replace the LEDs, contact the company: PUK ITALIA GROUP srl - via San Giorgio 16 - 20851 LISSONE (MB) ITALY

Recommendations

- 1) verify that the equipment used to connect our devices to enjoy all the guarantees required under European law;
- 2) use the cables, connectors and quality materials for electrical wiring;
- 3) Products with IP65/68 degree make the wiring / connections with accessories provide the same degree IP of the selected product (available in the catalog);
- 4) In the case of installations outside is not recommended to install the power supplies in the formwork and / or in the junction box without adequate protection
- 5) Terminal block not included. Installation may require advice from a qualified person. For wiring use a terminal complies with EN60998-2-1, EN 60998-2-2

Choice of installation location

The unit should be positioned so that when in use is not subject to direct radiation from the sun or other heat sources . High temperatures reduce the life and efficiency of the components or the LED module .

Note on corrosion protection

For installation and maintenance must be especially careful not to damage the coating powder . Damage combined action of water could cause corrosion.

Recommend mounting the device in a place with a pH value between 5 and 8. In ambient environment the assembly and maintenance of all components require the appropriate security measures . The chemicals damage the corrosion protection

INSTALLATION:

-SWITCH-OFF THE POWER SUPPLY BEFORE CARRYING OUT ANY MAINTENANCE OPERATIONS

1. Drill holes in the wall according to dimensions indicated in the table and insert adheguate wall plugs (not included in the package).
2. Make the electrical connection to the line
3. Fix the luminaire to the wall (it is advisable to rotate the lighting fixture so as to have access to the fixing brackets), align the fixture using a spirit level
4. If you need to use a longer accessory bracket, unscrew the hexagonal screw and replace it.

Hole for recessing

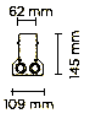

- Cod. 201102 62mm (109mm) x 294mm
- Cod. 201106 62mm (109mm) x 584mm
- Cod. 201110 62mm (109mm) x 884mm
- Cod. 201114 62mm (109mm) x 1184mm

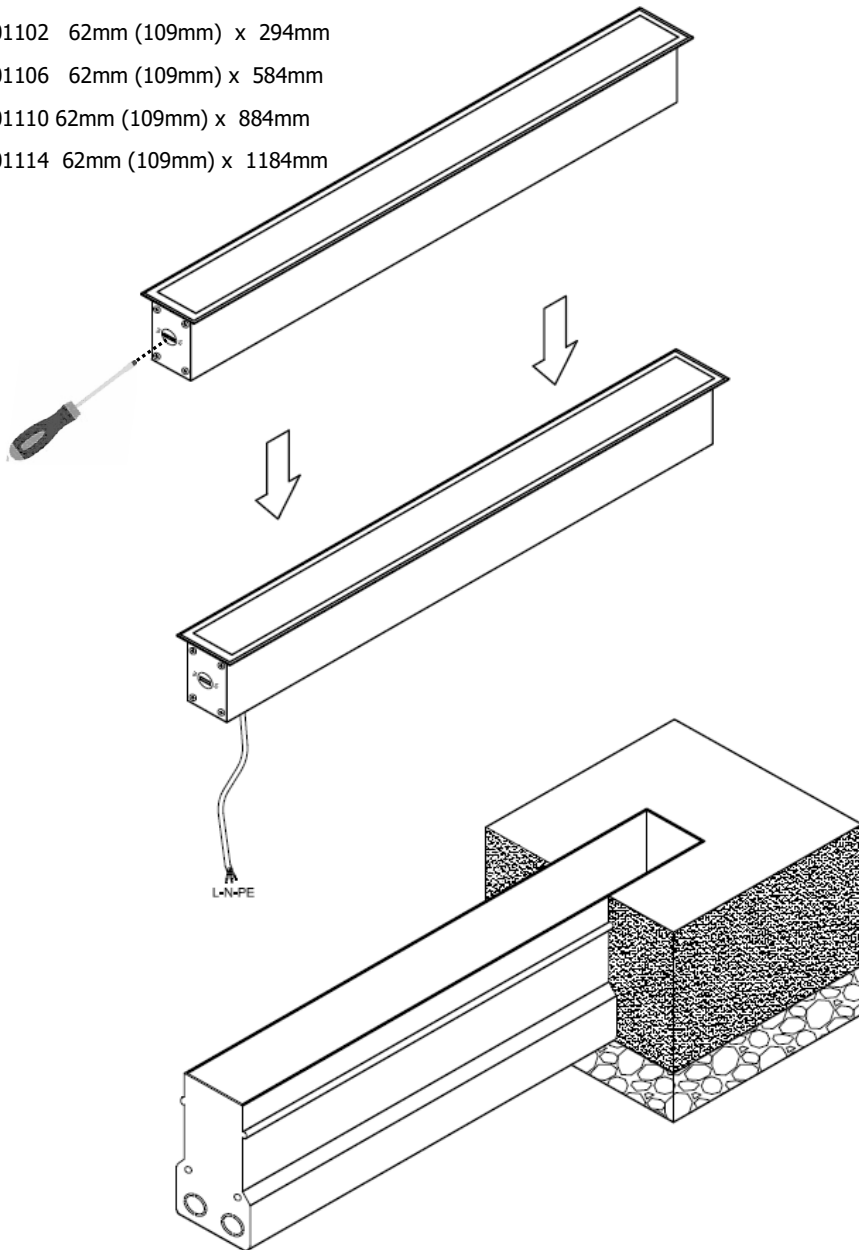
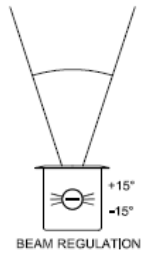

DRAINAGE BED

CLASS III

BROWN WIRE + Positive



BLUE WIRE— Negative

CLASS I

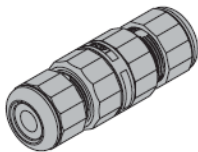

See the connector accessory instruction

L	Life / Linea / Leitung Ligne / Linea / Fas Fase / Фаза / Vaihe Linha	Brown / Marrone / Braun Brun / Marrón / Brun Bruin / коричневый / ruskea Marrom
N	Neutral / Neutro / Null Neutre / Neutro / Nolla Nul / Ноль / Nolla Neutro	Blue / Blu / Blau Bleu / Azul / Blå Blauw / СИНИЙ / Sininen Azul
	Earth / Terra / Erde Terre / Tierra / Jord Aarde / Земля / Suojamaa Terra	Yellow-Green / Giallo-Verde / Gelb-Grün Jaune-Vert / Amarillo-Verde / Gul-Grön Geel-Groen / Желто-зеленый Keltainen-Vihreä / Amarelo-Verde

DALI

The DALI control voltage is a functional extra low voltage (FELV). During installation, ensure that the basic insulation between the main power supply line (LV) and the BUS DALI control conductors

Cable colors:

L	Live	Brown
N	Neutral	Blue
PE	Earth	Yellow/green

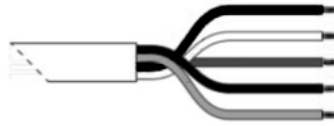

DALI 1	BLACK
DALI 2	GREY
EARTH	YELLOW/GREEN
NEUTRAL	BLUE
LIVE	BROWN

DA	Da=Dali 1	Black
DA	Da=Dali 2	Grey



RAEE - WEEE

- GB** Directive 2002/96/CE (Waste Electrical and Electronic Equipment - WEEE): information for users
The crossed out wheeled bin label that can be found on your product indicates that this product should not be disposed of via the normal household waste stream. To prevent possible harm to the environment or human health please separate this product from other waste streams to ensure that it can be recycled in an environmentally sound manner. For more details on available collection facilities please contact your local government office or the retailer where you purchased this product.
- I** DIRETTIVA 2002/96/CE (Rifiuti di Apparecchiature Elettriche ed Elettroniche - RAEE): informazioni agli utenti
L'etichetta con il cassonetto barrato presente sul prodotto indica che il prodotto non deve essere smaltito tramite la procedura normale di smaltimento dei rifiuti domestici. Per evitare eventuali danni all'ambiente e alla salute umana separare questo prodotto da altri rifiuti domestici in modo che possa venire riciclato in base alle procedure di rispetto ambientale. Per maggiori dettagli sui centri di raccolta disponibili, contattare l'ufficio governativo locale o il rivenditore del prodotto.
- D** Richtlinie 2002/96/EU (Elektro- und Elektronik- Altgeräte - WEEE):
Benutzerinformationen
Der Aufkleber mit durchgekreuzter Mülltonne an diesem Produkt weist darauf hin, dass dieses Produkt nicht im normalen Hausmüll entsorgt werden darf. Zur Vermeidung einer möglichen Beeinträchtigung der Umwelt oder der menschlichen Gesundheit darf dieses Produkt nicht in den Hausmüll gegeben werden, um zu gewährleisten, dass es in einer umweltverträglichen Weise recycelt wird. Wenden Sie sich für Informationen zu Entsorgungseinrichtungen an die zuständige Behörde oder das Geschäft, in dem Sie dieses Produkt erworben haben.
- F** Directive 2002/96/CE (Déchets d'équipements électriques et électroniques - DEEE):
informations aux utilisateurs
L'étiquette apposée sur ce produit et représentant une poubelle à roulettes rayée indique que le produit ne peut être mis au rebut avec les déchets domestiques normaux. Afin d'éviter d'éventuels dommages au niveau de l'environnement ou de la vie humaine, veuillez séparer ce produit des autres déchets de manière à garantir qu'il soit recyclé de manière sûre au niveau environnemental. Pour plus de détails sur les sites de collecte existants, veuillez contacter l'administration locale ou le détaillant auprès duquel vous avez acheté ce produit.
- E** Directiva 2002/96/CE (Residuos de aparatos eléctricos y electrónicos - RAEE):
Información para el usuario
La etiqueta de un contenedor tachado que hallará en su producto indica que este producto no se puede tirar con la basura doméstica normal. Para impedir posibles daños medioambientales o para la salud, separe este producto de otros canales de desecho para garantizar que se recicle de una forma segura para el medio ambiente.
Para más información sobre las instalaciones de recolección disponibles, diríjase a las autoridades locales o al punto de venta donde adquirió este producto
- SE** Directive 2002/96/CE (Waste Electrical and Electronic Equipment - WEEE) information for users

Symbolen med en överkorsad soptunna innebär att denna produkt inte får kastas i vanligt hushållsavfall. För att skydda miljön och hälsan bör denna produkt inte kastas tillsammans med vanligt hushållsavfall utan lämnas för återvinning på tillbörligt sätt. Örmerinformation om uppsamlingsplatser, kontakta en lokal myndighet eller den återförsäljare som du köpte produkten från.



NL Richtlijn 2002/96/EG (Afgedankte Elektrische en Elektronische Apparaten - AEEA):

informatie voor de gebruikers
Op uw product is een label van een rolcontainer met een kruis erdoor aangebracht. Dit wil zeggen dat dit product niet bij het normale huishoudelijk afval mag worden gedaan. Om eventuele schade aan het milieu of de gezondheid van de mens te voorkomen moet dit product gescheiden van al het ander afval worden ingezameld, zodat het op een verantwoorde wijze kan worden verwerkt. Voor meer informatie over uw lokale afvalinzameling wendt u zich tot uw gemeente of de leverancier bij wie u dit product hebt gekocht.

This information only applies to customers in the European Union, according to Directive 2002/96/EC OF THE EUROPEAN PARLIAMENT AND OF THE COUNCIL OF 27 January 2003 on waste electrical and electronic equipment (WEEE) and legislation transposing and implementing it into the various national legal systems.