



807007 - 807010

RING POLE MINI HP

Designed by
NAVA + AROSIO

Floodlight for outdoor installation on a pole diam. 60 mm or 76 mm, with 355° swivel pole attachment and allowing horizontal adjustment of +90° / -40°. Phospho-chromatised and polyester powder coated die-cast copper-free aluminium base and head, tempered safety glass, moulded silicone gaskets and o-rings, with screws in stainless steel. Swivel pole joint with graduated scale and mechanical aiming lock. Built-in LED driver, with 1 x CREE XHP35 LED. IP66 rating.

807007

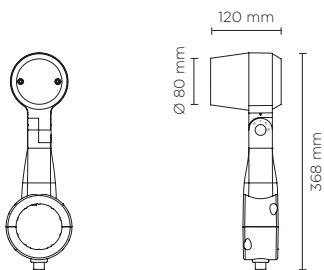

807010

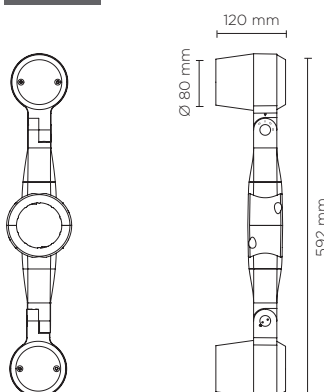

Technical features



Available on request



Technical data







IP Rating	IP66
IK Rating	IK10
Material	High corrosion resistance die-cast copper-free aluminum body
Coating	Polyester powder coating with phosphochromating pre-finish
Screws	Stainless steel
Transformer	Electrical power supply 220/240V 50/60Hz built-in
Gasket	Silicone rubber
Glass	Tempered
Cable gland	M16 rubber grommet
Power cable	3 Mt. Power cable included



NEW AESTHETIC POLE ATTACHMENT AVAILABLE ON REQUEST

AC085 - POLE PLATE

Pole plate for pole mounting of all Ring models, suitable to be used with poles diam. min 76 mm and diam. max 120 mm. Can be positioned on various staggered levels or on a single level, with the same pole. Made in phospho-chromatised and polyester powder coated die-cast copper-free aluminum material, moulded silicone gaskets and screws in stainless steel.

807007		SINGLE RING POLE MINI HP - 8 WATT 220-240V 50-60HZ		
light source	light beam options	lumen output (lm)	lumin. efficacy (lm/w)	
3000°K warm-white				
high-power led	 4°	690	86.25	
high-power led	 10°	662	82.75	
high-power led	 28°	642	80.25	
4000°K neutral-white				
high-power led	 4°	703	87.88	
high-power led	 10°	676	84.50	
high-power led	 28°	656	82.00	
2700°K CCT available on request				







Colors options

-  Textured Grey RAL 9006
-  Anthracite Grey RAL 7016
-  Matt Black (on request)

Technical data

Wattage	8 WATT
Light source	1 x CREE XHP35 LED
Gross weight	2,00 Kg



807010		DOUBLE RING POLE MINI HP - 2X8 WATT 220-240V 50-60HZ		
light source	light beam options	lumen output (lm)	lumin. efficacy (lm/w)	
3000°K warm-white				
high-power led	 4°	2 x 690	86.25	
high-power led	 10°	2 x 662	82.75	
high-power led	 28°	2 x 642	80.25	
4000°K neutral-white				
high-power led	 4°	2 x 703	87.88	
high-power led	 10°	2 x 676	84.50	
high-power led	 28°	2 x 656	82.00	
2700°K CCT available on request				

Colors options

-  Textured Grey RAL 9006
-  Anthracite Grey RAL 7016
-  Matt Black (on request)

Technical data

Wattage	2X8 WATT
Light source	2 x CREE XHP35 LED
Gross weight	3,50 Kg



POLES & ACCESSORIES

Full technical details of poles and accessories for poles are available at the end of the catalogue

BURIED POLES	
code	h. mm.
809901	3.500
809902	4.500
809903	5.500
809909	TOP CAP DIAM 76mm.

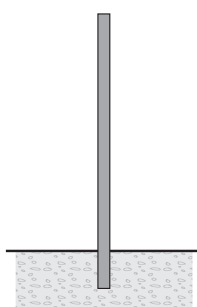

POLES WITH BASE-PLATE	
code	h. mm.
809904	3.000
809905	4.000
809906	5.000
809907	ACC.
809909	TOP CAP DIAM 76mm

