



807001 - 807004

## RING POLE MINI

Designed by  
NAVA + AROSIO

Floodlight for outdoor installation on a pole diam. 60 mm or 76 mm, with 355° swivel pole attachment and allowing horizontal adjustment of +90° / -40°. Phospho-chromatised and polyester powder coated die-cast copper-free aluminium base and head, tempered safety glass, moulded silicone gaskets and o-rings, with screws in stainless steel. Swivel pole joint with graduated scale and mechanical aiming lock. Built-in LED driver, with 1 COB CREE "CXB 1310" LED. IP66 rating.

807001

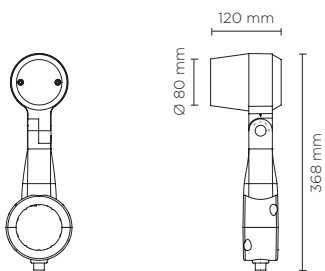

807004

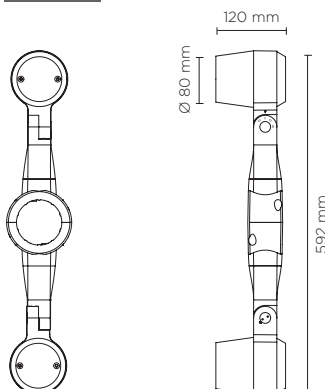

### Technical features



### Available on request



### Technical data







IP Rating	IP66
IK Rating	IK10
Material	High corrosion resistance die-cast copper-free aluminum body
Coating	Polyester powder coating with phosphochromating pre-finish
Screws	Stainless steel
Transformer	Electrical power supply 220/240V 50/60Hz built-in
Gasket	Silicone rubber
Glass	Tempered
Cable gland	M16 rubber grommet
Power cable	3 Mt. Power cable included



### NEW AESTHETIC POLE ATTACHMENT AVAILABLE ON REQUEST

#### AC085 - POLE PLATE

Pole plate for pole mounting of all Ring models, suitable to be used with poles diam. min 76 mm and diam. max 120 mm. Can be positioned on various staggered levels or on a single level, with the same pole. Made in phospho-chromatised and polyester powder coated die-cast copper-free aluminum material, moulded silicone gaskets and screws in stainless steel.







807001		SINGLE RING POLE MINI - 10 WATT 220-240V 50-60HZ		
light source	light beam options	lumen output (lm)	lumin. efficacy (lm/w)	
<b>3000°K warm-white</b>				
cob led	 14°	1.100	110	
cob led	 35°	1.060	106	
cob led	 55°	1.000	100	
<b>4000°K neutral-white</b>				
cob led	 14°	1.200	120	
cob led	 35°	1.140	114	
cob led	 55°	1.083	108	
<b>2700°K CCT</b> available on request				

#### Colors options

-  Textured Grey RAL 9006
-  Anthracite Grey RAL 7016
-  Matt Black (on request)

Technical data	
Wattage	10 WATT
Light source	1 COB CREE "CXB 1310" LED
Gross weight	2,00 Kg



807004		DOUBLE RING POLE MINI - 2X10 WATT 220-240V 50-60HZ		
light source	light beam options	lumen output (lm)	lumin. efficacy (lm/w)	
<b>3000°K warm-white</b>				
cob led	 14°	2 x 1.100	110	
cob led	 35°	2 x 1.060	106	
cob led	 55°	2 x 1.000	100	
<b>4000°K neutral-white</b>				
cob led	 14°	2 x 1.200	120	
cob led	 35°	2 x 1.140	114	
cob led	 55°	2 x 1.083	108	
<b>2700°K CCT</b> available on request				

#### Colors options

-  Textured Grey RAL 9006
-  Anthracite Grey RAL 7016
-  Matt Black (on request)

Technical data	
Wattage	2X10 WATT
Light source	2 COB CREE "CXB 1310" LED
Gross weight	3,50 Kg



## POLES & ACCESSORIES

Full technical details of poles and accessories for poles are available at the end of the catalogue

BURIED POLES	
code	h. mm.
809901	3.500
809902	4.500
809903	5.500
809909	TOP CAP DIAM 76mm.

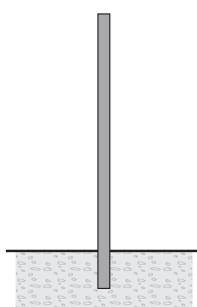

POLES WITH BASE-PLATE	
code	h. mm.
809904	3.000
809905	4.000
809906	5.000
809907	ACC.
809909	TOP CAP DIAM 76mm

