

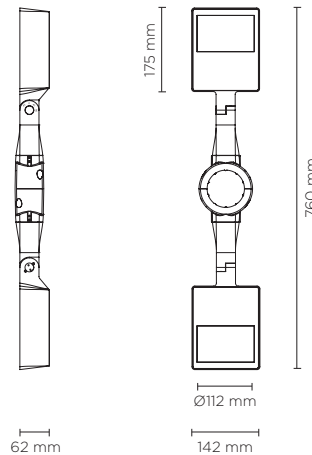

806009 - 806010

DOUBLE ZEUS POLE MEDIUM

2 x Square pole mounted floodlight for outdoor installation on a pole diam. 60 mm or 76 mm. Phospho-chromatised and polyester powder coated die-cast copper-free aluminium base and head, tempered safety glass, moulded silicone gaskets and o-rings, with screws in stainless steel. Symmetrical or asymmetrical wide light distribution. Swivel joint with graduated scale and mechanical aiming lock. Built-in LED driver, with 56 x mid-power SAMSUNG 2835 LED. IP66 rating.



SYMMETRIC LIGHT DISTRIBUTION

ASYMMETRIC LIGHT DISTRIBUTION



Technical features





Available on request





Technical data

IP Rating	IP66
IK Rating	IK09
Material	High corrosion resistance die-cast copper-free aluminum body
Coating	Polyester powder coating with phosphochromating pre-finish
Screws	Stainless steel
Transformer	Electrical power supply 220/240V 50/60Hz built-in
Gasket	Silicone rubber
Glass	Tempered
Cable gland	M16 rubber grommet
Power cable	3 Mt. Power cable included
Gross weight	5,00 Kg

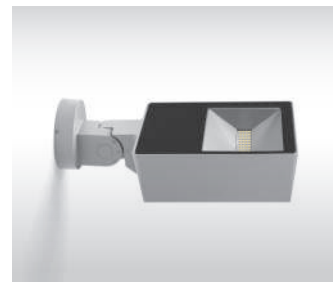
806009	DOUBLE ZEUS POLE MEDIUM SYMM 2 X 20 WATT 220-240V 50-60HZ		
light source	light beam options	lumen output (lm)	lumin. efficacy (lm/w)
3000°K warm-white			
mid-power led	 110°	2 x 1.510	75.50
4000°K neutral-white			
mid-power led	 110°	2 x 1.560	78.00



806010	DOUBLE ZEUS POLE MEDIUM ASYMM 2 X 20 WATT 220-240V 50-60HZ		
light source	light beam options	lumen output (lm)	lumin. efficacy (lm/w)
3000°K warm-white			
mid-power led	 110°x70°	2 x 1.560	78.00
4000°K neutral-white			
mid-power led	 110°x70°	2 x 1.610	80.50

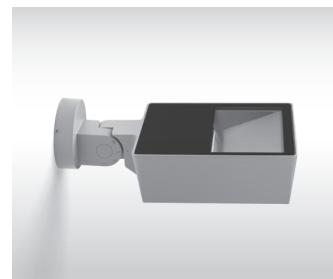

Colors options

-  Textured Grey RAL 9006
-  Anthracite Grey RAL 7016
-  Matt Black (on request)

POLES & ACCESSORIES

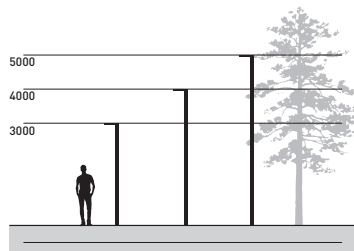

BURIED POLES

code	article	h. mm.	description
809901	cylindrical pole 3,5 meters to be buried	3.500	Cylindrical pole made in steel S235JR (UNI EN 10219) hot galvanized (UNI EN 1461), diameter 76 mm, thickness 4 mm.
809902	cylindrical pole 4,5 meters to be buried	4.500	Phospho-chromatised and polyester powder coated. Total height including 500 mm to be buried into the ground. Includes IP54 cover plate 132x38 mm and terminal block in double insulation.
809903	cylindrical pole 5,5 meters to be buried	5.500	
809909	Top cap for pole diam. 76 mm.		

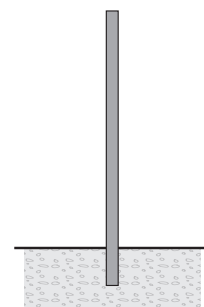

POLES WITH BASE-PLATE

code	article	h. mm.	description
809904	cylindrical pole 3 meters with base-plate	3.000	Cylindrical pole made in steel S235JR (UNI EN 10219) hot galvanized (UNI EN 1461), diameter 76 mm, thickness 4 mm.
809905	cylindrical pole 4 meters with base-plate	4.000	Phospho-chromatised and polyester powder coated. With base plate dim. 250x250 mm, thickness 10 mm
809906	cylindrical pole 5 meters with base-plate	5.000	Includes IP54 cover plate 132x38 mm and terminal block in double insulation.
809907	anchorage unit for base-plate		Base plate dim. 250x250 mm, thickness 3 mm, made in galvanized steel complete of nr. 4 anchorage threaded bolts
809909	Top cap for pole diam. 76 mm.		

