



805002-805006

## FLASH POLE MEDIUM COB

Round pole-mounted floodlight for outdoor installation on a pole diam. 60 mm or 76 mm. Phospho-chromatised and polyester powder coated die-cast copper-free aluminium body, tempered safety glass, moulded silicone gasket and stainless steel screws. Clamp for pole diam 60 mm or 76 mm included. Built-in LED driver 220-240V 50-60Hz, with 1 CREE CXA 1512 COB LED. IP65 rating.

805002

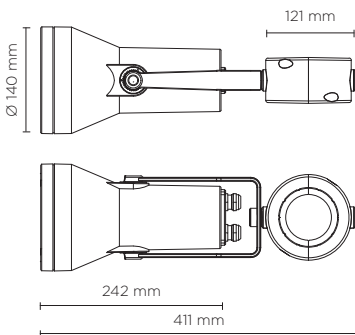

805006

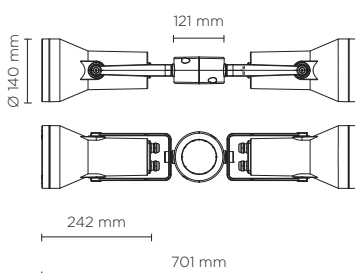

### Technical features



### Available on request



### Technical data

IP Rating	IP65
IK Rating	IK09
Material	High corrosion resistance die-cast copper-free aluminum body
Coating	Polyester powder coating with phosphochromating pre-finish
Screws	Stainless steel
Transformer	Electronic power supply 220/240V 50/60Hz built-in
Gasket	Silicone rubber
Glass	Tempered
Cable gland	Double nickel-plated brass cable gland PG11
Power cable	3 mt. neoprene power cable included

AC-026 Anti-glare visor for hydroflash medium



Graduated stainless steel insert

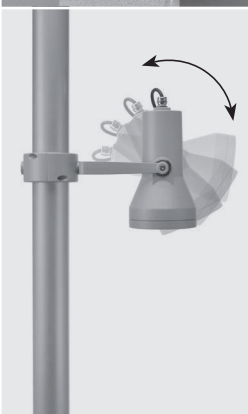
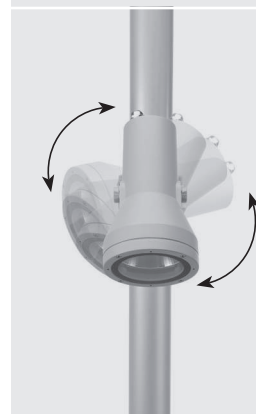

<b>805002</b>		<b>SINGLE FLASH POLE MEDIUM COB - 18 WATT 220-240V 50-60HZ ELECTRONIC</b>	
<b>light source</b>	<b>light beam options</b>	<b>lumen output (lm)</b>	<b>lumin. efficacy (lm/w)</b>
<b>3000°K warm-white</b>			
cob led	 35°	1.530	85.00
<b>2700°K CCT</b> available on request			

**Colors options**

-  Textured Grey RAL 9006
-  Anthracite Grey RAL 7016
-  Matt Black (on request)

**Technical data**

Wattage	18 WATT
Light source	NR. 1 CREE CXA 1512 LED
Gross weight	3,00 Kg



<b>805006</b>		<b>DOUBLE FLASH POLE MEDIUM COB - 2 X 18 WATT 220-240V 50-60HZ ELECTRONIC</b>	
<b>light source</b>	<b>light beam options</b>	<b>lumen output (lm)</b>	<b>lumin. efficacy (lm/w)</b>
<b>3000°K warm-white</b>			
cob led	 35°	2 x 1.530	85.00
<b>2700°K CCT</b> available on request			

**Colors options**

-  Textured Grey RAL 9006
-  Anthracite Grey RAL 7016
-  Matt Black (on request)

**Technical data**

Wattage	2 x 18 WATT
Light source	NR. 2 x 1 CREE CXA 1512 LED
Gross weight	5,60 Kg



**POLES & ACCESSORIES**

Full technical details of poles and accessories for poles are available at the end of the catalogue

BURIED POLES	
code	h. mm.
809901	3.500
809902	4.500
809903	5.500
809909	TOP CAP DIAM 76mm

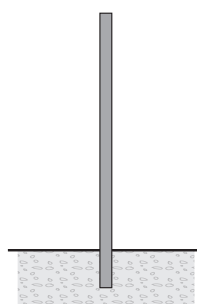

POLES WITH BASE-PLATE	
code	h. mm.
809904	3.000
809905	4.000
809906	5.000
809907	ACC.
809909	TOP CAP DIAM 76mm

