

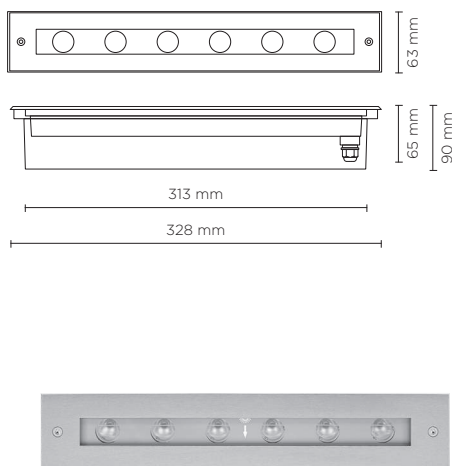

502013

STEP LINEAR 04

Recessed linear steplight for outdoor installation in the wall, asymmetrical light distribution, phospho-chromatised and polyester powder coated die-cast copper-free aluminium body, stainless steel frame, tempered clear glass, polypropilene housing for recess, moulded silicone gasket and stainless steel screws. Built-in LED driver 220-240V 50-60Hz, with 6 high-power OSRAM LED. IP65 rating.



light source	light beam options	lumen output (lm)	lumin. efficacy (lm/w)
3000°K warm-white			
high power led	45° x 35° asymmetric	410	68.34

Finish color options:

Stainless Steel

Technical features



Technical data

Wattage	6 WATT
IP Rating	IP65
IK Rating	IK08
Material	High corrosion resistance die-cast copper-free aluminum body
Coating	Polyester powder coating with phosphochromating pre-finish
Frame	Stainless Steel AISI 304
Light source	NR. 6 x OSRAM LED
Screws	Stainless steel
Transformer	Electronic power supply 220/240V 50/60Hz built-in
Cable	0.5 mt. neoprene power cable included
Gasket	Silicone rubber
Glass	Tempered
Gross weight	1,30 Kg
Included	Polypropilene recessing box

