

401806-07

HYDROFLEX TOP

1.000 / 4.000 mm length, 16mm x 15 mm section, opal encapsulated flexible LED strip for linear lighting (straight or bended) outdoor and indoor wall-recessed installation; surface mounted version through installation accessories to be ordered separately. LED circuit completely encapsulated with UV and high-temperatures resistant Polyurethane sheath, with white (outside) and milky finish (over light emission), dot free and homogeneous light emission surface. Double power cable with male/female connectors included, suitable for in-line installation. Cutable each 50 mm. Remote driver 24V DC needed. With low-power SMD3014 Lumileds LED. IP68 rating.

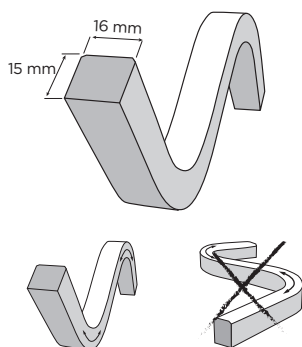
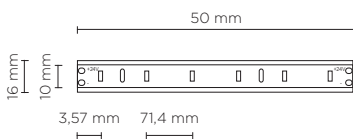
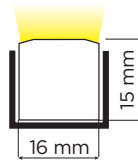

Technical features



Technical data

Material	High performances Polyurethane, UV resistant, saltwater resistant
	No yellowish after years
	Dot-free and homogeneous light emission
Light source	SMD3014 Lumileds LED
Transformer	24V DC remote driver needed
	Supplied with Male/Female connectors for in-line installation

NO LIGHT INTERRUPTION

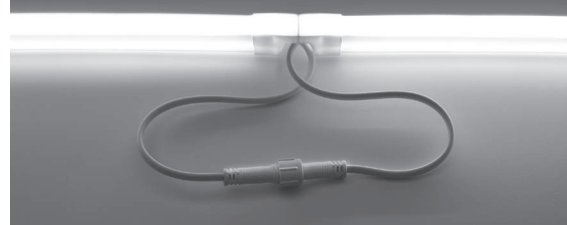

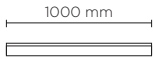

401806		HYDROFLEX TOP 1000		
light source	light beam options	lumen output (lm)	lumin. efficacy (lm/w)	
3000°K warm-white				
low power led	diffused	750	75.00	

Finish color options:

Milky

remote driver selection

brand	manufacturer code	type	watt	IP rate	numbers of fixtures
Meanwell	LPV-20-24	constant voltage 24V DC	20W	IP67	1
Meanwell	LPV-35-24	constant voltage 24V DC	35W	IP67	min 1 - max 2
Meanwell	LPV-60-24	constant voltage 24V DC	60W	IP67	min 1 - max 5
Meanwell	LPV-100-24	constant voltage 24V DC	100W	IP67	min 1 - max 9

4000 mm

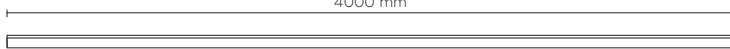

401807		HYDROFLEX TOP 4000		
light source	light beam options	lumen output (lm)	lumin. efficacy (lm/w)	
3000°K warm-white				
low power led	diffused	3.000	75.00	

Finish color options:

Milky

remote driver selection

brand	manufacturer code	type	watt	IP rate	numbers of fixtures
Meanwell	LPV-60-24	constant voltage 24V DC	60W	IP67	1
Meanwell	LPV-100-24	constant voltage 24V DC	100W	IP67	min 1 - max 2

AC034 MOUNTING CLIP FOR HYDROFLEX TOP

Mounting clip for Hydroflex Top, realized in Stainless steel, clip to be applied every 40 cm, to secure with screws. Ideal for bended installation on a wall or ceiling.



AC035 ALUMINUM LINEAR PROFILE FOR HYDROFLEX TOPSIDE

1.000 mm Linear profile for Hydroflex Top, realized in Anodized aluminum.

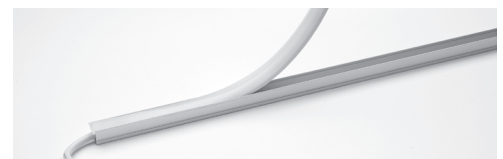

AC036 END CAP FOR HYDROFLEX TOP

End cap for Hydroflex Top, realized in Polyurethane, to be applied at the end of the line, after Hydroflex cut.

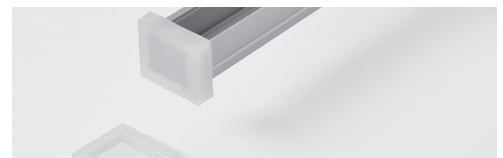

AC061 CURVED STAINLESS STEEL PROFILE FOR HYDROFLEX TOP

1.000 mm curved profile for Hydroflex Top realized in stainless steel AISI 304, to secure with screws. Ideal for curved installation.

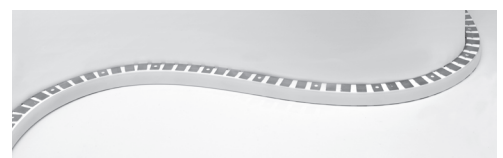

AC054 LEADER CABLE FOR HYDROFLEX RANGE

Initial cable to connect the driver to first luminaire of an in-line installation of multiple luminaires, all connected to one driver. Kit contains two leader cables, one with male connector and one with female connector, to allow start the installation from both sides.

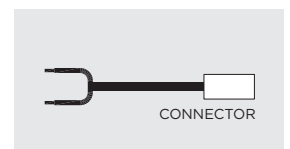
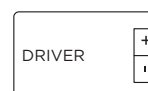

Technical data	
Wattage	10 WATT
IP Rating	IP68

Technical data	
Wattage	40 WATT
IP Rating	IP68