

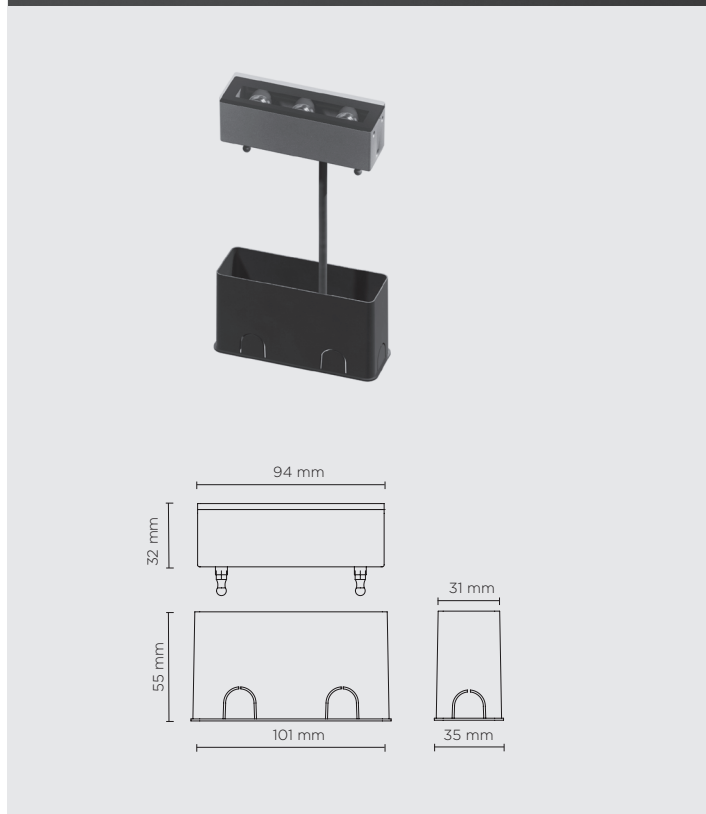

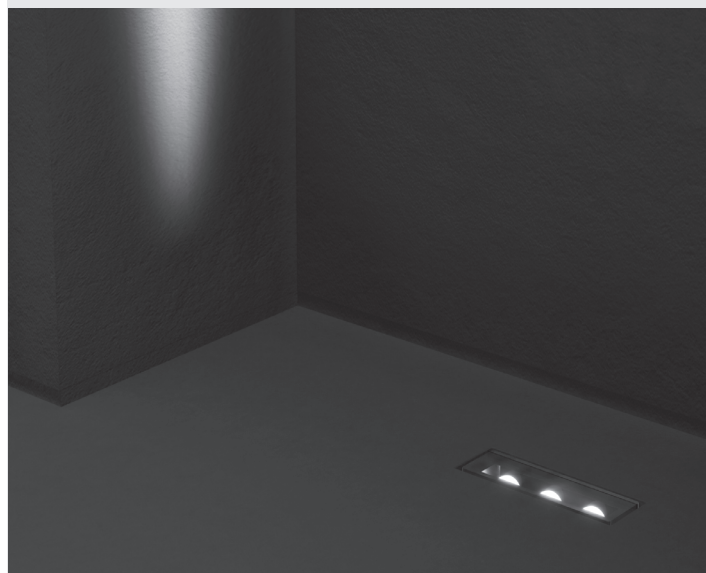

209006

HYDROFLOOR NANO LINEAR TRIMLESS BLADE



Trimless version, all other details are same
as model 209003



500 mA - LED POWER 4.5W

light source	light beam options	lumen output (lm)	lumin. efficacy (lm/w)
2700°K warm-white			
high-power led	 20°x100°	315	70.00
3000°K warm-white			
high-power led	 20°x100°	330	73.33
4000°K neutral-white			
high-power led	 20°x100°	345	76.66

700 mA - LED POWER 6W

light source	light beam options	lumen output (lm)	lumin. efficacy (lm/w)
2700°K warm-white			
high-power led	 20°x100°	420	70.00
3000°K warm-white			
high-power led	 20°x100°	440	73.33
4000°K neutral-white			
high-power led	 20°x100°	460	76.66

remote driver selection

brand	manufacturer code	type	watt	IP rate	numbers of fixtures
ALVIT Italy	AL1435S-IP	constant current 350mA	14W	IP67	min 1 - max 4
ALVIT Italy	AL1450S-IP	constant current 500mA	14W	IP67	min 1 - max 3
ALVIT Italy	AL1470S-IP	constant current 700mA	14W	IP67	min 1 - max 2
TCI Italy	152014/350	constant current 350mA	17W	IP68	min 1 - max 5
TCI Italy	152014/500	constant current 500mA	24W	IP68	min 1 - max 5
TCI Italy	152014/700	constant current 700mA	30W	IP68	min 1 - max 4