

COINY + COINY BOLLARD

-COD. 102101

-COD. 602301

ASSEMBLY AND OPERATING INSTRUCTIONS:



-Class I fitting electric grounding is needed



-Getting rid of as urban waste forbidden
-Separate collection is mandatory when the product is at the end of its life

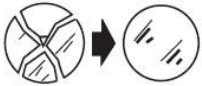

-Replace the damaged protective glass



Made in Italy

IP66

IK10



Retain the instructions

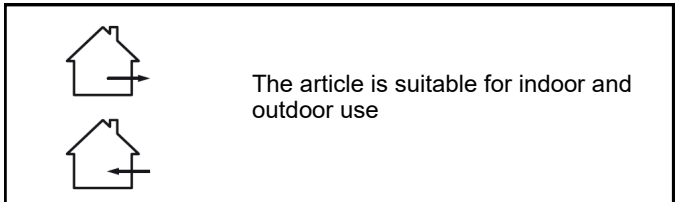

The article is suitable for indoor and outdoor use

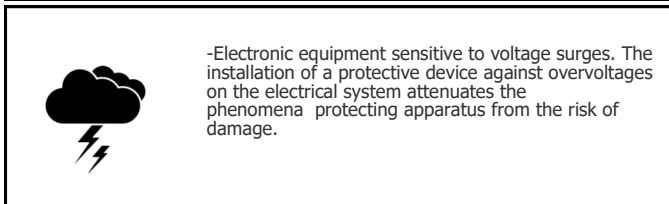

-Electronic equipment sensitive to voltage surges. The installation of a protective device against overvoltages on the electrical system attenuates the phenomena protecting apparatus from the risk of damage.

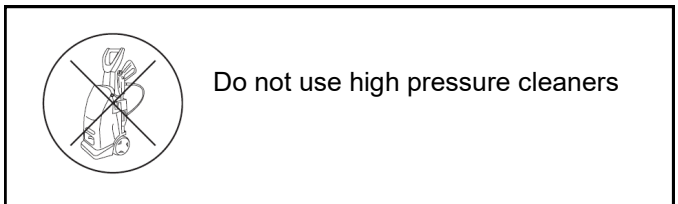

Do not use high pressure cleaners

NB: These assembly instructions must be given to end users for correct maintenance and so that they know how to change the bulb. The appliance must not be tampered with or transformed and it must be installed and used as supplied and in compliance with the National Rules on Installations. Any non-compliant installations will invalidate all forms of guarantee. The company cannot be held

COD. 102101

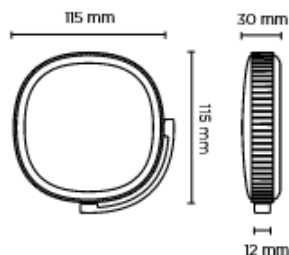

COINY

- Power consumption : 8W
- Voltage 220/240V 50-60 Hz
- Color Temperature : 3000K - 4000K
- Beam angle : 18° - 36° - 60°
- Insulation class: I
- IK rating : IK08
- IP protection: IP66
- Gross weight: 1.2kg

COD. 602301

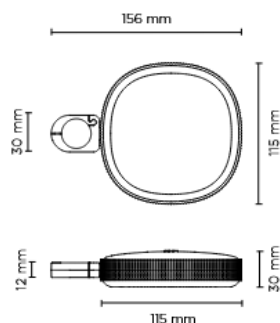

COINY BOLLARD

- Power consumption : 8W
- Voltage 220/240V 50-60 Hz
- Color Temperature : 3000K - 4000K
- Beam angle : 18° - 36° - 60°
- Insulation class: I
- IK rating : IK08
- IP protection: IP66
- Gross weight: 1.2kg

Recommendations

- 1) verify that the equipment used to connect our devices to enjoy all the guarantees required under European law;
- 2) use the cables, connectors and quality materials for electrical wiring;
- 3) Products with IP66 degree make the wiring / connections with accessories provide the same degree IP of the selected product (available in the catalog);
- 4) In the case of installations outside is not recommended to install the power supplies in the formwork and / or in the junction box without adequate protection
- 5) Honey-comb louvre must be installed directly from the manufacturer . Please mention it during the order

Choice of installation location

The unit should be positioned so that when in use is not subject to direct radiation from the sun or other heat sources . High temperatures reduce the life and efficiency of the components or the LED module .

Note on corrosion protection

For installation and maintenance be especially careful not to damage the coating powder . Damage combined action of water could cause corrosion.

-In the case of damage to the external flexible cable, it must be replaced by the manufacturer, or its assistance service, or equivalent qualified personnel in order to avoid dangers

-In the case of glass breakage, contact the device manufacturer to replace it. Replace the screen with an original replacement

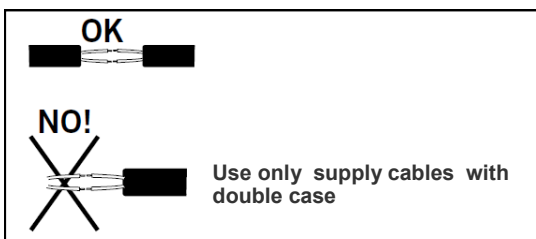

ACCESSORIES

AC044
SPIKE



AC111
VISOR



AC010
HONEYCOMB LOUVER

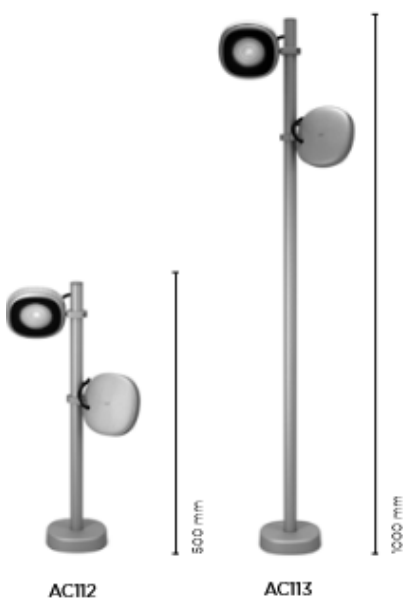
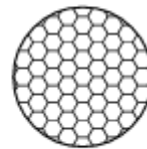

AC112 PIPE L 500 mm + BASE

Extension pipe length 500 mm made in anodized aluminum with phospho-chromatised and polyester powder coating; complete with fixing base.



AC113 PIPE L 1000 mm + BASE

Extension pipe length 1.000 mm made in anodized aluminum with phospho-chromatised and polyester powder coating; complete with fixing base.



Coiny installation

1. Loose the grub-screw (using the tool included in the package) and remove the fixing bracket
2. Prepare holes in desired fixing point and fix the luminaire bracket tighten the screw of fischer plug (not included in the package)
3. Fix the luminaire body to the bracket tighten the grub-screw and make the adequate electrical connection
4. Make the desired regulation of the luminaire

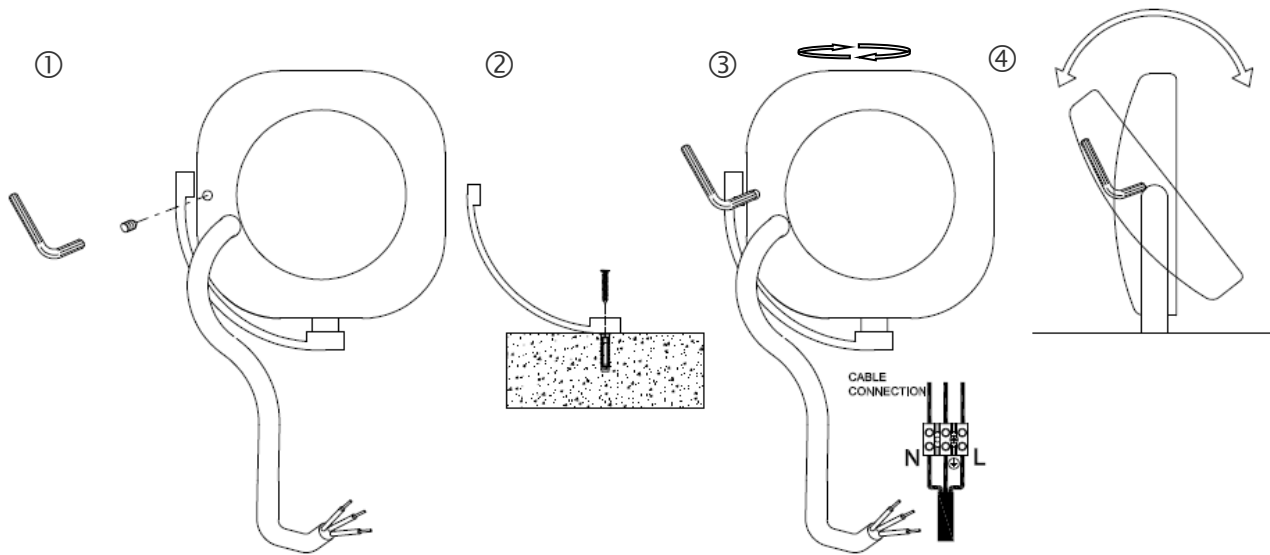

Coiny bollard installation

1. Prepare holes in desired feeding point using fischers plugs (not included in the package)
2. Move the cover base and fix the base to the wall/floor tighten the fischer screws.
3. Insert the luminaire in the pole (the cable will be placed into the hollow of the pole)
4. Tighten the grub-screw (using the tool included in the package) place the luminaire in the desired position and make the adequate electrical connection.
5. Prepare holes in desired fixing point and fix the luminaire bracket tighten the screw of fischer plug (not included in the package)
6. Fix the luminaire body to the bracket tighten the grub-screw and make the adequate electrical connection

It is possible to place maximum two luminaire on each pole

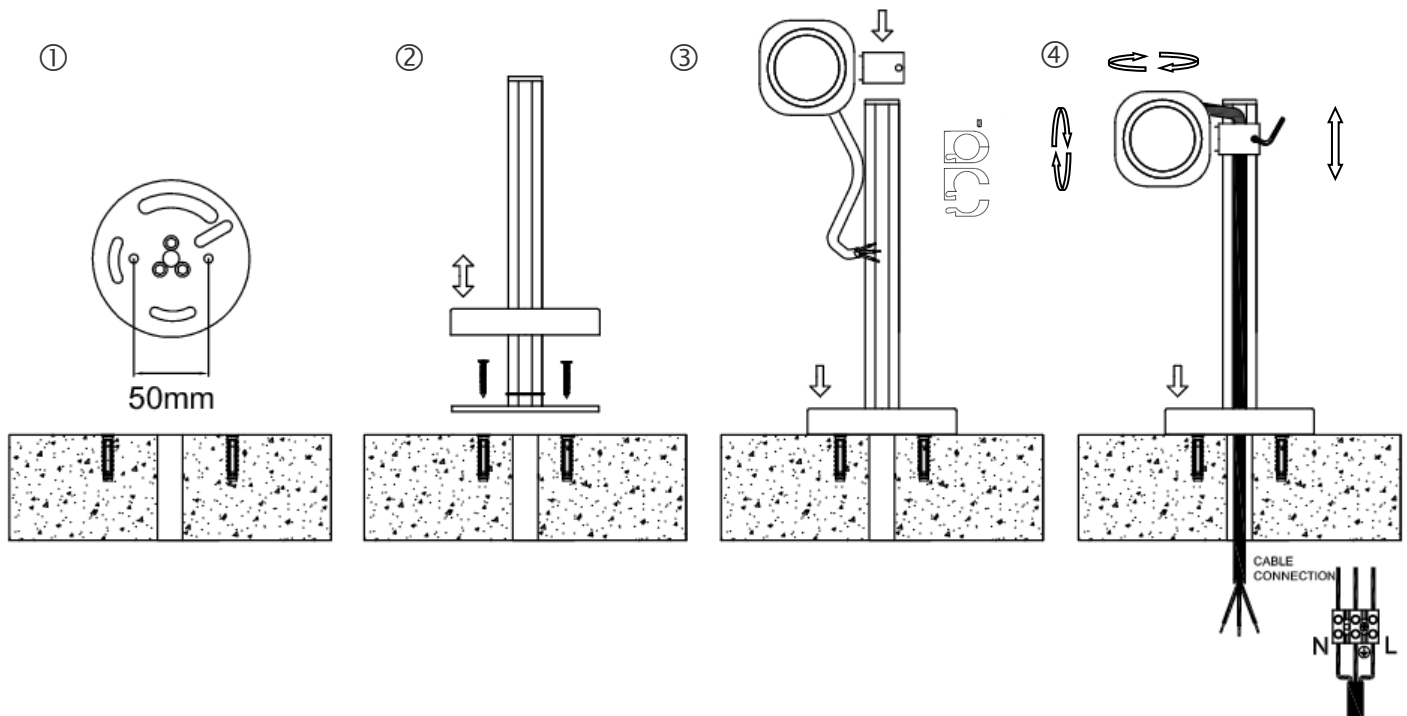

Coiny bollard installation for 2 luminaire.

1. Insert the luminaires in the pole (the cables will be placed into the hollow of the pole)
2. The cables must pass through the groove of the fixing base therefore prepare a cable passage 4cm offset

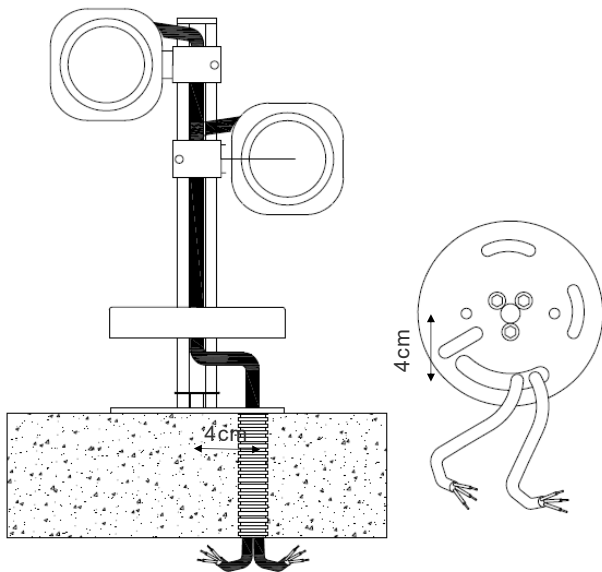

Coiny bollard spike installation

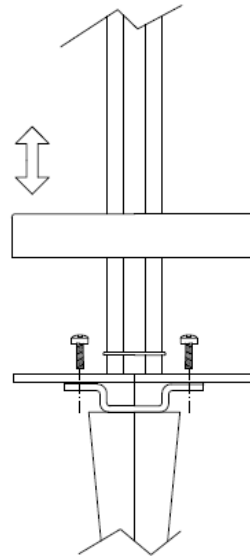

See the connector accessory instruction



RAEE - WEEE

CLASS I

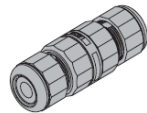

L	Life / Linea / Leitung Ligne / Linea / Fas Fase / Фаза / Vaihe Linha	Brown / Marrone / Braun Brun / Marrón / Brun Bruin / коричневый / Muskea Marrom
N	Neutral / Neutro / Null Neutre / Neutro / Nolla Nul / Ноль / Nolla Neutro	Blue / Blu / Blau Bleu / Azul / Blå Blauw / синий / Sininen Azul
⊕	Earth / Terra / Erde Terre / Tierra / Jord Aarde / Земля / Suojamaa Terra	Yellow-Green / Giallo-Verde / Gelb-Grün Jaune-Vert / Amarillo-Verde / Gul-Grön Geel-Groen / Желто-зелёный Keltainen-Vihreä / Amarelo-Verde

GB Directive 2002/96/CE (Waste Electrical and Electronic Equipment - WEEE): information for users
The crossed out wheeled bin label that can be found on your product indicates that this product should not be disposed of via the normal household waste stream. To prevent possible harm to the environment or human health please separate this product from other waste streams to ensure that it can be recycled in an environmentally sound manner. For more details on available collection facilities please contact your local government office or the retailer where you purchased this product.

I DIRETTIVA 2002/96/CE (Rifiuti di Apparecchiature Elettriche ed Elettroniche - RAEE): informazioni agli utenti
L'etichetta con il cassonetto barrato presente sul prodotto indica che il prodotto non deve essere smaltito tramite la procedura normale di smaltimento dei rifiuti domestici. Per evitare eventuali danni all'ambiente e alla salute umana separare questo prodotto da altri rifiuti domestici in modo che possa venire riciclato in base alle procedure di rispetto ambientale. Per maggiori dettagli sui centri di raccolta disponibili, contattare l'ufficio governativo locale o il rivenditore del prodotto.

D Richtlinie 2002/96/EU (Elektro- und Elektronik- Altgeräte - WEEE):
Benutzerinformationen
Der Aufkleber mit durchgekrenzter Mülltonne an diesem Produkt weist darauf hin, dass dieses Produkt nicht im normalen Hausmüll entsorgt werden darf. Zur Vermeidung einer möglichen Beeinträchtigung der Umwelt oder der menschlichen Gesundheit darf dieses Produkt nicht in den Hausmüll gegeben werden, um zu gewährleisten, dass es in einer umweltverträglichen Weise recycelt wird. Wenden Sie sich für Informationen zu Entsorgungseinrichtungen an die zuständige Behörde oder das Geschäft, in dem Sie dieses Produkt erworben haben.

F Directive 2002/96/CE (Déchets d'équipements électriques et électroniques - DEEE):
informations aux utilisateurs
L'étiquette apposée sur ce produit et représentant une poubelle à roulettes rayée indique que le produit ne peut être mis au rebut avec les déchets domestiques normaux. Afin d'éviter d'éventuels dommages au niveau de l'environnement ou de la vie humaine, veuillez séparer ce produit des autres déchets de manière à garantir qu'il soit recyclé de manière sûre au niveau environnemental. Pour plus de détails sur les sites de collecte existants, veuillez contacter l'administration locale ou le détaillant auprès duquel vous avez acheté ce produit.

E Directiva 2002/96/CE (Residuos de aparatos eléctricos y electrónicos - RAEE):
Información para el usuario
La etiqueta de un contenedor tachado que hallará en su producto indica que este producto no se puede tirar con la basura doméstica normal. Para impedir posibles daños medioambientales o para la salud, separe este producto de otros canales de desecho para garantizar que se recicle de una forma segura para el medio ambiente.
Para más información sobre las instalaciones de recolección disponibles, dirijase a las autoridades locales o al punto de venta donde adquirió este producto

SE Directive 2002/96/CE (Waste Electrical and Electronic Equipment - WEEE) information for users

Symbolen med en överkorsad soptunna innebär att denna produkt inte får kastas i vanligt hushållsavfall. För att skydda miljön och hälsan bör denna produkt inte kastas tillsammans med vanligt hushållsavfall utan lämnas för återvinning på tillbörligt sätt. Ör mer information om uppsamlingsplatser, kontakta en lokal myndighet eller den återförsäljare som du köpte produkten från.

NL Richtlijn 2002/96/EG (Afgedankte Elektrische en Elektronische Apparaten - AEEA):

informatie voor de gebruikers
Op uw product is een label van een rolcontainer met een kruis erdoor aangebracht. Dit wil zeggen dat dit product niet bij het normale huishoudelijk afval mag worden gedaan. Om eventuele schade aan het milieu of de gezondheid van de mens te voorkomen moet dit product gescheiden van al het ander afval worden ingezameld, zodat het op een verantwoorde wijze kan worden verwerkt. Voor meer informatie over uw lokale afvalinzameling wendt u zich tot uw gemeente of de leverancier bij wie u dit product hebt gekocht.



This information only applies to customers in the European Union, according to Directive 2002/96/EC OF THE EUROPEAN PARLIAMENT AND OF THE COUNCIL OF 27 January 2003 on waste electrical and electronic equipment (WEEE) and legislation transposing and implementing it into the various national legal systems.