

HYDROTWIST MICRO-MINI-MEDIO-MAXI

ASSEMBLY AND OPERATING INSTRUCTIONS:

COD. 101301

COD. 101302

COD. 101303

COD. 101304



-Class I fitting electric grounding is needed

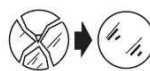

-replace the damaged protective glass

-glass features: plane float glass - safety tempered



-getting rid of as urban waste forbidden
-separate collection is mandatory when the product is at the end of its life

IP65

-Complete protection from dust and water jets









Made in Italy

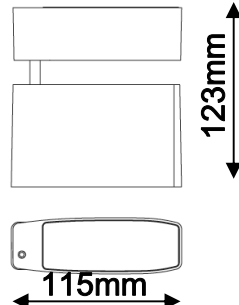

GB Retain the instructions.
I Conservare le istruzioni.
D Retain the instructions.
F Bewahren Sie die Anleitung.
E Conservez ces instructions.

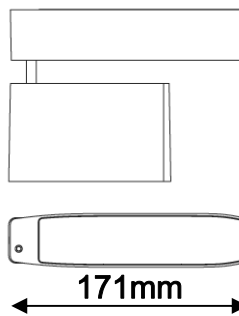
NB: These assembly instructions must be given to end users for correct
The appliance must not be tampered with or transformed and it must
National Rules on Installations. Any non-compliant installations will
responsible for damage caused by incorrect assembly.

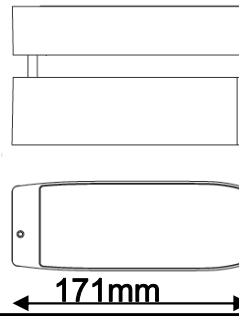
maintenance and so that they know how to change the bulb.
be installed and used as supplied and in compliance with the
invalidate all forms of guarantee. The company cannot be held

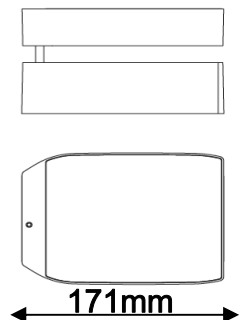
<p>COD. 101301</p>  <p>endless fixture head positions</p>		<p>HYDROTWIST MICRO LED</p> <ul style="list-style-type: none"> -Power consumption : 4.5W -Voltage :220-240V 50-60Hz -Color Temperature : 3000-4000K -Lens Type : 18-36° -Insulation class: I -IP protection: IP65 -Gross weight: 1kg
<p>COD.101302</p>  <p>endless fixture head positions</p>		<p>HYDROTWIST MINI LED</p> <ul style="list-style-type: none"> -Power consumption : 7W -Voltage :220-240V 50-60Hz -Color Temperature : 3000-4000K -Lens Type : 18-36° -Insulation class: I -IP protection: IP65 -Gross weight: 1.2kg
<p>COD.101303</p>  <p>endless fixture head positions</p>		<p>HYDROTWIST MEDIUM LED</p> <ul style="list-style-type: none"> -Power consumption : 14W -Voltage :220-240V 50-60Hz -Color Temperature : 3000-4000K -Lens Type : 18-36° -Insulation class: I -IP protection: IP65 -Gross weight: 1.8kg
<p>COD.101304</p>  <p>endless fixture head positions</p>		<p>HYDROTWIST MAXI LED</p> <ul style="list-style-type: none"> -Power consumption : 27W -Voltage :220-240V 50-60Hz -Color Temperature : 3000-4000K -Lens Type : 18-36° -Insulation class: I -IP protection: IP65 -Gross weight: 2.5kg

THE WARRANTY IS FALLING IN THE FOLLOWING CASES:

- 1) Malfunctions due to improper use of the product, modifications, repairs inadequate, negligence on the part of the installer / electrician, failure to assembly instructions and / or data plate;
- 2) Installations in plants not comply with the general safety;
- 3) Damage caused by natural causes such as lightning, fire or flooding;
- 4) Damage caused by wiring / connections with IP degree lower than the selected product.
- 5) Damage occurring during shipment of the product. In these cases the damage will be to charge and notify the carrier;
- 6) The warranty covers only the integrity of the product and NOT any costs of removal of the same;

Recommendations

- 1) verify that the equipment used to connect our devices to enjoy all the guarantees required under European law;
- 2) use the cables, connectors and quality materials for electrical wiring;
- 3) Products with IP65/68 degree make the wiring / connections with accessories provide the same degree IP of the selected product (available in the catalog);
- 4) In the case of installations outside is not recommended to install the power supplies in the formwork and / or in the junction box without adequate protection

Choice of installation location

The unit should be positioned so that when in use is not subject to direct radiation from the sun or other heat sources . High temperatures reduce the life and efficiency of the components or the LED module .

Relamping and maintenance:

- The relamping must be done with maximum attention avoiding to dirty the sealing gasket and its contact surface. It is therefore necessary before
- If the gasket is damaged, deformed or not in perfect conditions it is necessary to change it
- it is essential to do a frequent cleaning of the glass and of the outer surface of the fixture to avoid build up of mud and dirtiness resulting in dangerous overheating due to uncorrect light and heat dissipation. Clean carefully the glass screen removing limestone deposits by means of a scraper.

.The replacement must be done by a qualified electrician.

INSTALLATION:

-SWITCH-OFF THE POWER SUPPLY BEFORE CARRYING OUT ANY MAINTENANCE OPERATION

- 1 Remove the fixing bracket by uncsrewing the side hexagonal screw (pic 1)
- 2 Drill holes and place plugs type "fischer" (not included in the package) then fix the bracket to the wall(pic 2) (for dimensions see the drilling scheme below) and make the electrical connection.
- 3 Place the luminaire directly to the fixing bracket (pic3)
- 4 Fix the luminaire to the bracket using the hexagonal tool(included in the package)and tighten the fixing screw (pic4)
- 5 Make the regulation of the head in desired way by unscrewing and then tighten the regulation screw (pic 5)
- 6 AC37 accessory fix the bracket to the base using the screw included in the package

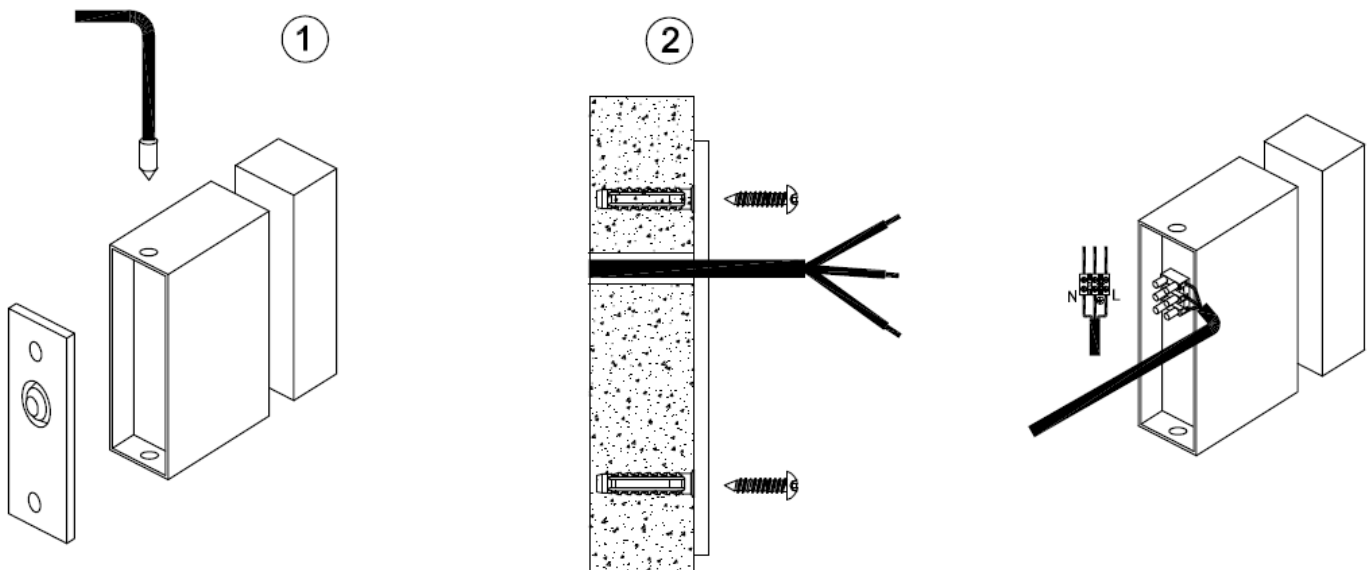

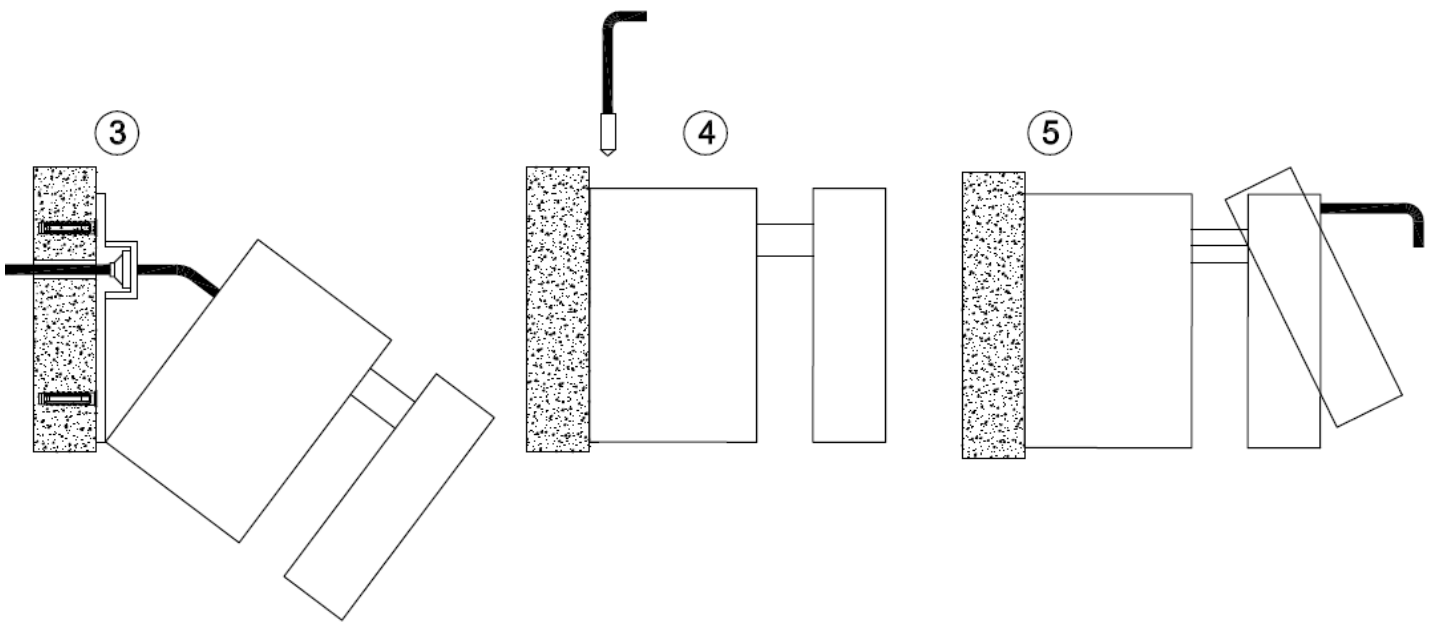

AC037

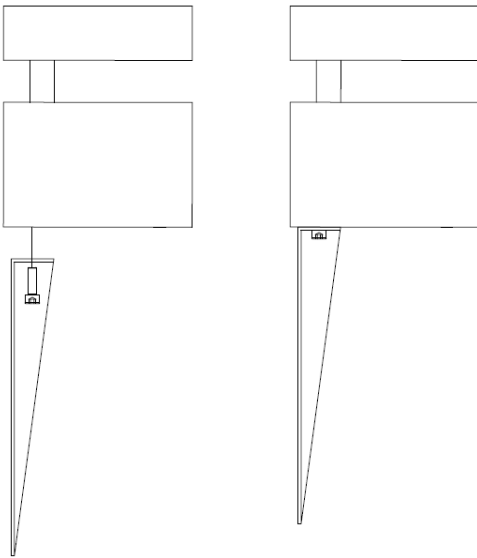

HOLES COD 101301/101302

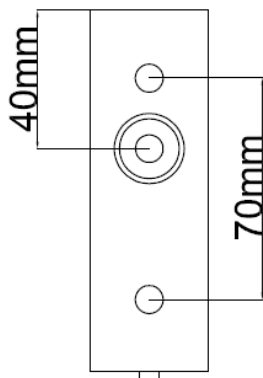

HOLES COD 101303

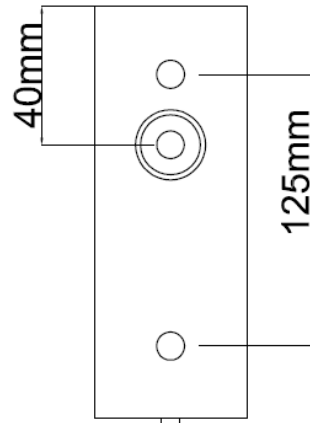

HOLES COD 101304

