



808001 - 808003

QUBO MEDIUM POLE

Designed by
NAVA + AROSIO

Pole-mounted projector for outdoor installation on a pole; with U shape fixing bracket allowing vertical adjustment of +90° / -40°. Phospho-chromatised and polyester powder coated die-cast copper-free aluminium base and head, tempered safety glass, moulded silicone gaskets, with screws in stainless steel. Built-in LED driver. IP66 rating.

808001

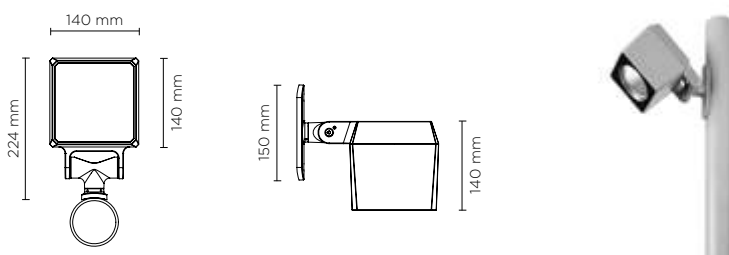

808003

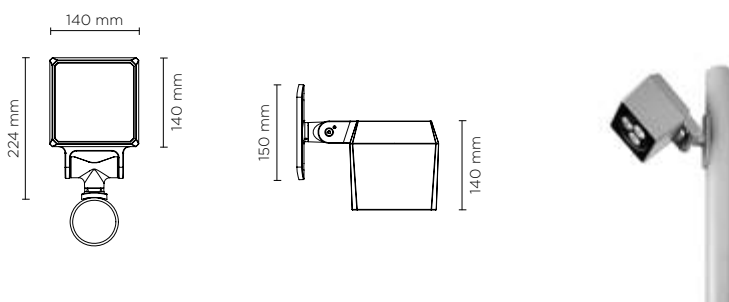

Technical features











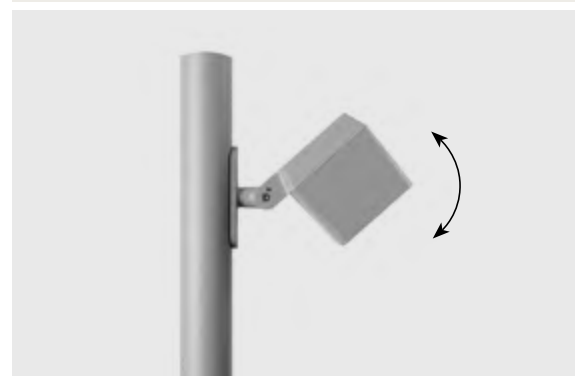

Available on request













Technical data

IP Rating	IP66
IK Rating	IK10
Material	High corrosion resistance die-cast copper-free aluminum body
Coating	Polyester powder coating with phosphochromating pre-finish
Screws	Stainless steel
Transformer	Electrical power supply 220/240V 50/60Hz built-in
Gasket	Silicone rubber
Glass	Tempered
Power cable	5 mt. Power cable included



808001		QUBO MEDIUM COB POLE - 16 WATT 220-240V 50-60HZ		
light source	light beam options	lumen output (lm)	lumin. efficacy (lm/w)	
3000°K warm-white				
cob led	 14°	1.900	118.75	
cob led	 35°	1.813	113.31	
cob led	 55°	1.722	107.62	
4000°K neutral-white				
cob led	 14°	2.000	125.00	
cob led	 35°	1.900	118.75	
cob led	 55°	1.805	112.81	
2700°K CCT available on request				
Colors options				
 Textured Grey RAL 9006	 Anthracite Grey RAL 7016	 Matt Black (on request)		

Technical data	
Wattage	16 WATT
Light source	1 x COB CREE "CXB 1512" LED
Gross weight	3,50 Kg

808003		QUBO MEDIUM HP POLE - 20 WATT 220-240V 50-60HZ		
light source	light beam options	lumen output (lm)	lumin. efficacy (lm/w)	
3000°K warm-white				
high-power led	 4°	2.050	102.50	
high-power led	 10°	2.000	100.00	
high-power led	 28°	1.950	97.50	
high-power led	 55°	1.658	82.88	
4000°K neutral-white				
high-power led	 4°	2.100	105.00	
high-power led	 10°	2.050	102.50	
high-power led	 28°	2.000	100.00	
high-power led	 55°	1.700	85.00	
2700°K CCT available on request				
Colors options				
 Textured Grey RAL 9006	 Anthracite Grey RAL 7016	 Matt Black (on request)		

Technical data	
Wattage	20 WATT
Light source	3 x CREE "XHP35" LED
Gross weight	3,50 Kg

POLES & ACCESSORIES

Full technical details of poles and accessories for poles are available at the end of the catalogue

BURIED POLES	
code	h. mm.
809901	3.500
809902	4.500
809903	5.500
809909	TOP CAP DIAM 76mm.

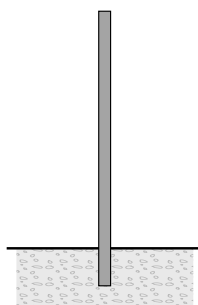

POLES WITH BASE-PLATE	
code	h. mm.
809904	3.000
809905	4.000
809906	5.000
809907	ACC.
809909	TOP CAP DIAM 76mm

